

SONY®



PLAYSTATION® 3

Quick Reference

About the PS3™ system documentation

The PS3™ system documentation includes the following:

- **Safety and Support**

Before using the product, carefully read this document first. It contains safety information related to use of the PS3™ system, troubleshooting, specifications and other information.

- **Quick Reference (this document)**

This document contains information on setting up the PS3™ system, preparing for use and basic hardware operations.

- **User's Guide (<http://manuals.playstation.net/document/>)**

This online document is accessed through the Internet and contains detailed information related to the use of the PS3™ system software (▶▶page 27).

Check that you have all of the following items. If any items are missing, contact the appropriate PlayStation® customer service helpline which can be found within every PlayStation®, PlayStation®2 and PLAYSTATION®3 software manual.

- PLAYSTATION®3 system
- SIXAXIS™ Wireless Controller
- Printed materials

- AC Power Cord

One of the following two cable types is supplied with the system. The plug configuration varies depending on the country or region.

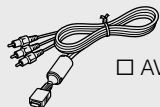

AV Cable



USB Cable



Ethernet Cable



Euro-AV Connector Plug
(supplied with the system sold in the UK only)



Friends

Chatting and exchanging messages



Network

Connecting to the Internet



Game

Playing games



Video

Playing video



Music

Playing music



Photo

Displaying images



Settings

Adjusting PS3™ system settings





Users

Selecting users to log in to the PS3™ system

Using "XMB" (XrossMediaBar)

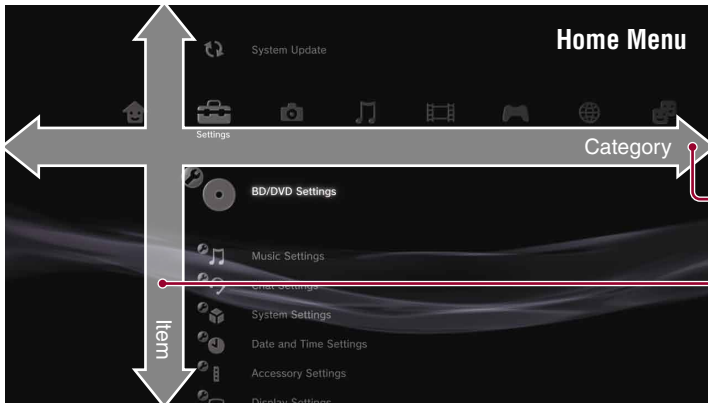
The PS3™ system includes a user interface called "XMB" (XrossMediaBar). The main screen for "XMB" is called the "Home Menu".



- 1 Select a category using the left or right button.
- 2 Select an item using the up or down button.
- 3 Press the  button to confirm the selected item.

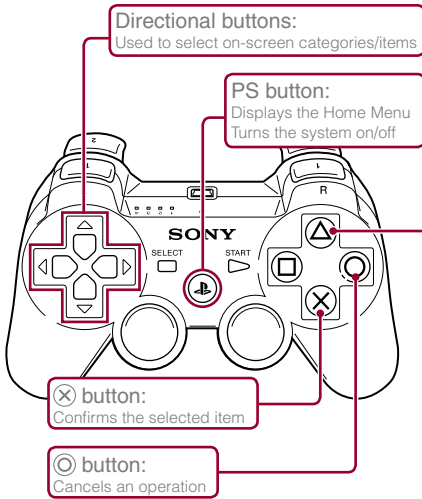

button: Displays the options menu/control panel

Selecting an icon and pressing the  button will display the options menu.

Pressing the  button during content playback will display the control panel.

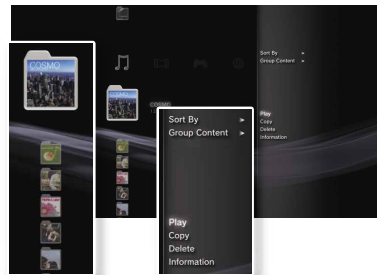

Icons

Options menu



Control panel

01 Getting started

Part names

System front

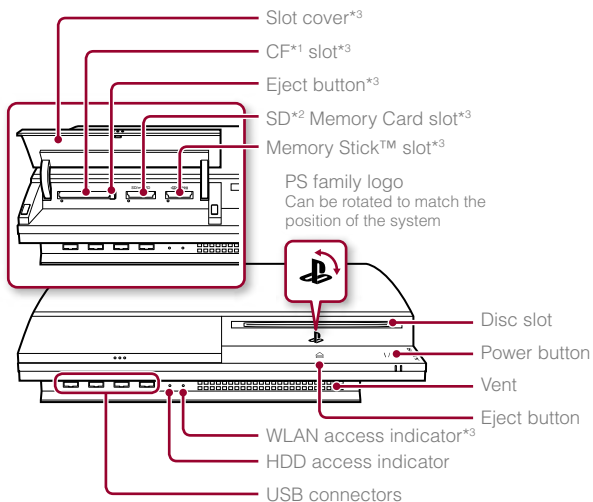

*1 CompactFlash® *2 Secure Digital *3 On equipped models only

⚠ Caution

- Do not use the system in a closed cabinet or other locations where heat may build up. Doing so may cause the system to overheat and may lead to fire, injury or malfunction.
- If the system's internal temperature becomes elevated, the power indicator will flash alternately in red and green. In this case, turn off the system (▶▶ page 13) and leave it unused for a while. After the system cools down, move it to a location with good ventilation, and then resume use.

System rear

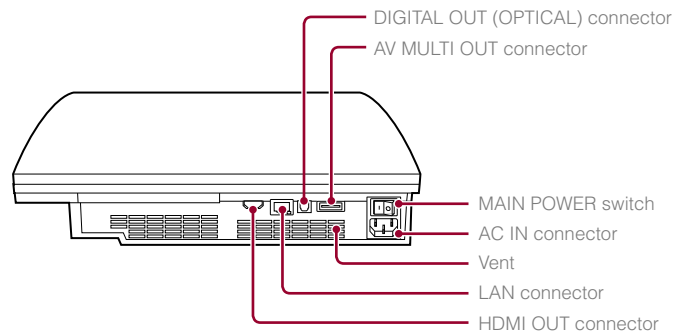

Hint

The system can be set in a horizontal or vertical position. Set as shown in the diagram at right when setting in the vertical position.

Notice

Do not place the system in an area subject to excessive dust or cigarette smoke. Dust build-up or cigarette smoke residue on the internal components (such as the lens) may cause the system to malfunction.

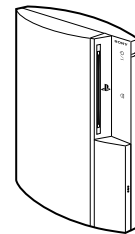

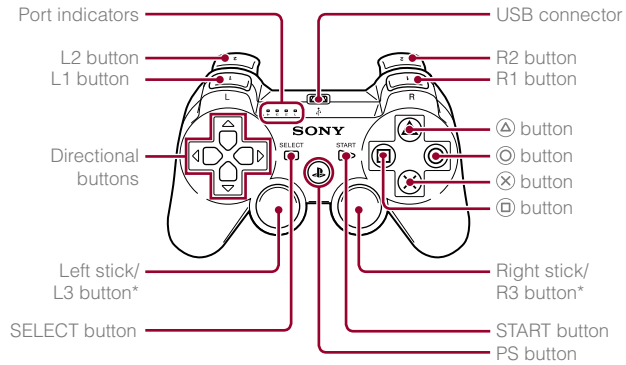
SIXAXIS™ Wireless Controller

* The L3 and R3 buttons function when the sticks are pressed.

Hint

For details on the Wireless Controller, see "Using the SIXAXIS™ Wireless Controller" (▶▶ page 14).

Setting up the PS3™ system

Procedure flow for setting up the system

Step 1: Connect to a TV.
 ▶▶ Page 6



Step 2: Connect digital audio devices.
 ▶▶ Page 9



Step 3: Connect the Ethernet Cable.
 ▶▶ Page 10



Step 4: Connect the AC Power Cord.
 ▶▶ Page 11



Step 5: Perform initial setup of the system software.
 ▶▶ Page 11

Step 1: Connect to a TV

Video output on the PS3™ system

The PS3™ system can output two types of resolution: HD and SD. Refer to the instruction manual for the TV in use to check which video mode is supported.

	HD (High Definition)			SD (Standard Definition)	
Video mode *1	1080p	1080i	720p	576p	576i *2
Aspect ratio	16:9	16:9	16:9	16:9 4:3	16:9 4:3

*1 This number indicates the number of scan lines. Note that "i" stands for "interlace" and "p" stands for "progressive". Using progressive results in high-quality video with minimal flickering.

*2 The video output setting on the system will display as "Standard (PAL)".

Screens showing the difference in resolution

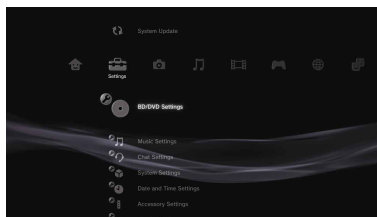



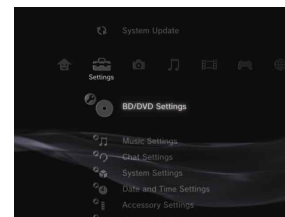

HD screen



SD screen

Video output cable types

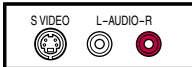
The resolution displayed on the TV varies depending on the input connectors on the TV and the type of cable in use. Select a cable to match the TV in use.

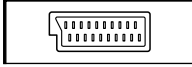
Cable type	Input connector on the TV	Supported video modes*1
HDMI Cable (sold separately)	HDMI IN connector 	1080p / 1080i / 720p / 576p
Component AV Cable (sold separately)	Component VIDEO IN connector 	1080p / 1080i / 720p / 576p / 576i*2
S VIDEO Cable (sold separately)	S VIDEO IN connector 	576i*2
AV Cable (supplied)	VIDEO IN connector (composite) 	576i*2
AV Cable (supplied) Euro-AV Connector Plug (supplied with the system sold in the UK only)	Euro-AV connector (SCART) 	576i*2

*1 Depending on the type of TV or content to be played, some video modes may not be supported.

*2 The video output setting on the system will display as "Standard (PAL)".

Getting started

Setting up the PS3™ system

Connection methods

⚠ Caution

- Do not plug the AC Power Cord for the system into an electrical outlet until you have made all other connections.
- The socket-outlet shall be installed near the equipment and shall be easily accessible.

Connecting to a TV using an HDMI Cable

Connect the system to the TV using an HDMI Cable (sold separately). An HDMI Cable can output both video and audio and enables you to enjoy digital-quality video and audio with minimal loss of picture quality.

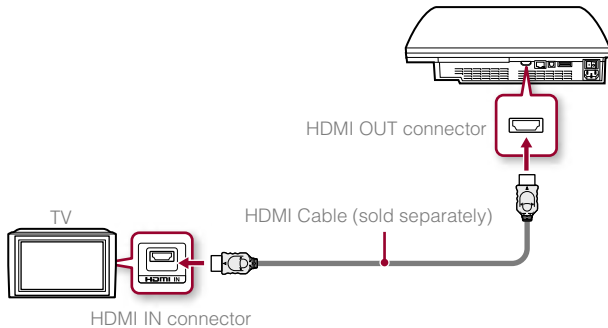

Connecting with other types of cables

Connect cables other than the HDMI Cable to the AV MULTI OUT connector on the system.

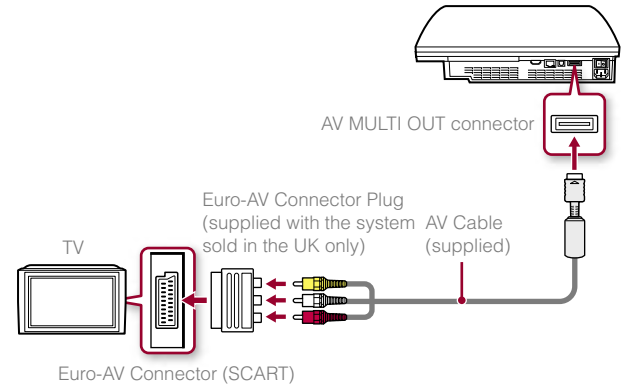

Example: When using the supplied AV Cable



Hint

If you change the type of cable used to connect the system, the picture may not be displayed. If this happens, turn off the system and then turn it on again by touching the power button on the system front until it makes a small beep (about 5 seconds). The picture will be displayed at the system's default resolution.

Step 2: Connect digital audio devices

You can connect audio devices that support digital audio output, such as an AV receiver for home entertainment use.

Hint

When connecting a digital audio device to the system, go to  (Settings) →  (Sound Settings) → "Audio Output Settings", and adjust the settings as necessary for the audio device.

Audio output on the PS3™ system

The supported channels may vary depending on the output connector to be used.

PS3™ system output connectors	Channels that can be used for output		
	2 Ch.	5.1 Ch.	7.1 Ch.
AV MULTI OUT connector	○	—	—
DIGITAL OUT (OPTICAL) connector *1	○	○	—
HDMI OUT connector	○	○	○ *2*3

*1 Audio from a Super Audio CD cannot be output from the DIGITAL OUT (OPTICAL) connector.

*2 A device compatible with Linear PCM 7.1 Ch. is required to output 7.1 Ch. audio from the HDMI OUT connector.

*3 This system does not support output from the DTS-HD 7.1 Ch. DTS-HD 7.1 Ch audio is output from a 5.1 or lower channel.

Connecting with an optical cable

The audio will be output from the optical cable. The picture will be output from the video output cable.

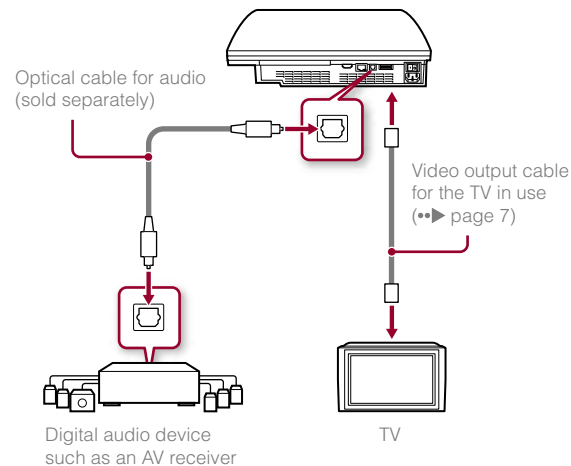

Connecting with an HDMI Cable

Both audio and video will be output from the HDMI Cable. You can output the TV picture via an audio device.

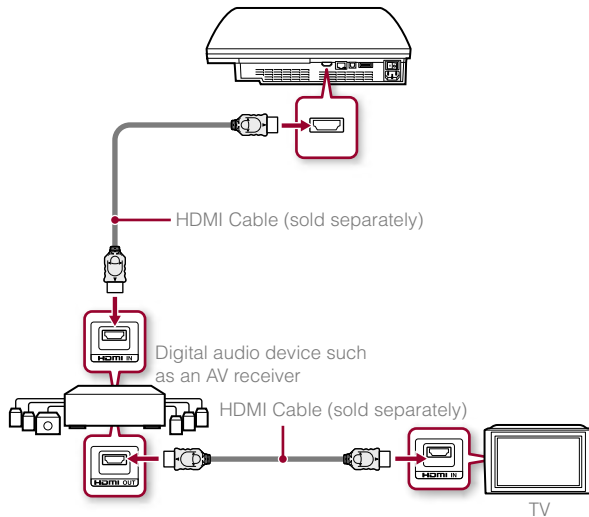

Hints

- If your TV is not equipped with an HDMI input connector, use a video output cable of the correct type for your TV (•▶ page 7) to connect it to the PS3™ system directly.
- If a device is connected to the PS3™ system via an HDMI Cable, do not turn off the device while the PS3™ system is turned on (power indicator is lit green). Doing so may cause sound distortions or produce abnormal sounds.

Step 3: Connect the Ethernet Cable

Using an Ethernet Cable, you can connect the system to the Internet. For details on network settings, see "Adjusting network settings" (•▶ page 22).

⚠ Caution

The system supports 10BASE-T, 100BASE-TX and 1000BASE-T networks. Do not connect a standard telephone line or other types of cords or cables that are not compatible with the system, as this may cause heat build-up, fire or malfunction.

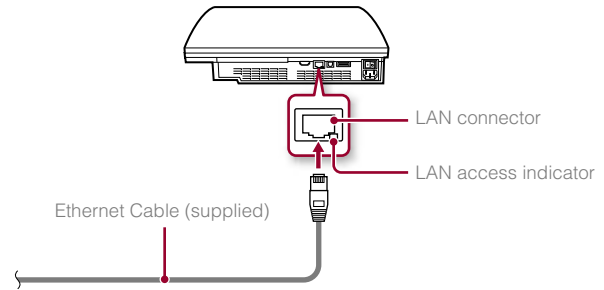

Hint

If using a PS3™ system that is equipped with the wireless LAN feature, you can connect to the Internet without using an Ethernet Cable. For details, see "Using a wireless connection" (•▶ page 23).

Step 4: Connect the AC Power Cord

Connect the AC Power Cord.

⚠ Caution

- Do not plug the AC Power Cord for the system into an electrical outlet until you have made all other connections.
- The socket-outlet shall be installed near the equipment and shall be easily accessible.

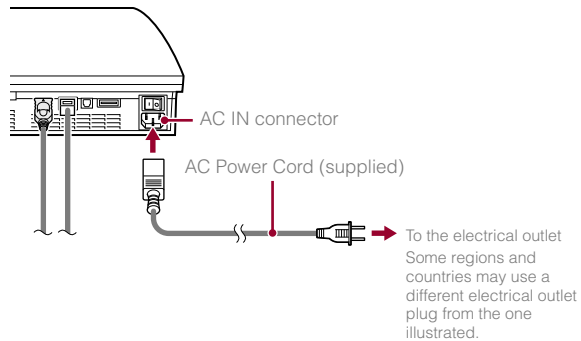

Step 5: Perform initial setup of the system software

After turning on the system, perform initial setup.

- 1 Turn on the TV.
- 2 Turn on the MAIN POWER switch.

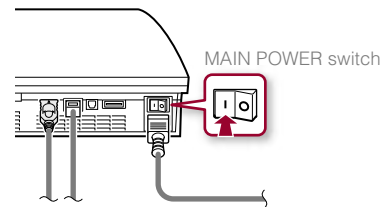

The power indicator will turn solid red to indicate that the system has entered standby mode.

- 3 Touch the power button.

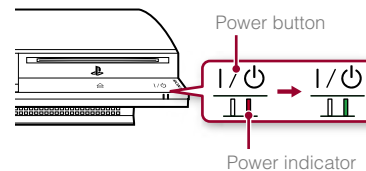

The power indicator turns green and the picture is displayed on the TV screen.

4 Connect the Wireless Controller to the system using a USB Cable.

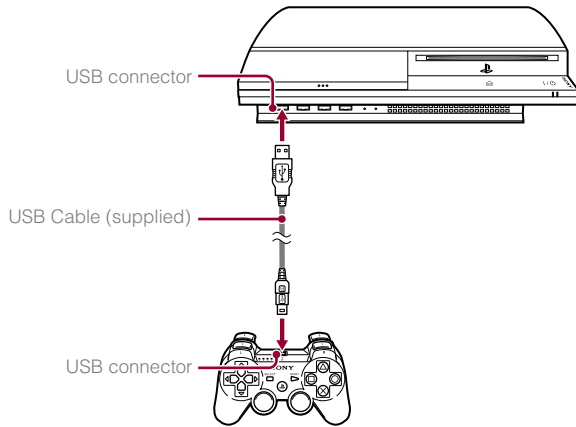

5 Press the PS button on the controller.

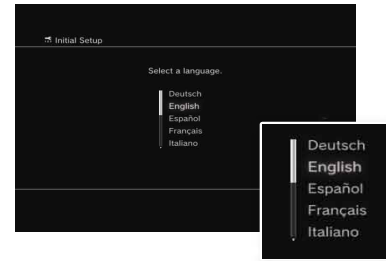

The system will recognise the Wireless Controller. After it has recognised the controller, the initial setup screen will be displayed.

6 Perform initial setup.





Follow the on-screen instructions to enter settings for system language, time zone, date and time and user name. After initial setup is completed, the Home Menu (▶▶ page 3) will be displayed on the TV screen.

Hints

- For details on entering text, see "Using the on-screen keyboard" (▶▶ page 29).
- Settings entered during initial setup can be changed under  (Settings) or  (Users). For details, refer to the online user's guide (▶▶ page 27).

Adjusting video output settings

Depending on the connector and the type of cable used, video output settings may need to be adjusted to display HD resolution on the TV screen (▶▶ page 6).

Go to  (Settings) →  (Display Settings) → "Video Output Settings" and follow the on-screen instructions to adjust the settings.

Turning the PS3™ system on and off

Using a SIXAXIS™ Wireless Controller

Press the PS button.

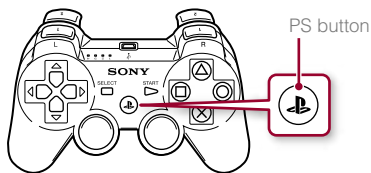

Turning off the system

Press and hold down the PS button for two seconds or longer. When the message "Turn off the system." is displayed on the screen, select it and then press the \otimes button.

Hint



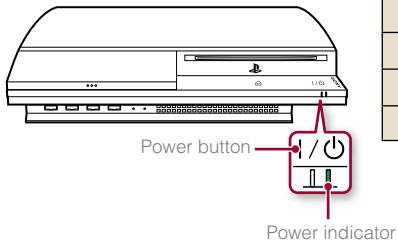

Before using a Wireless Controller you must first pair it with the system (▶▶ page 14).

Using the system button

1 Touch the power button.



Power indicator status

	Solid green	System turned on
	Flashing green	System turning off
	Solid red	System off (in standby mode)
	Off	MAIN POWER switch off

Turning off the system

Touch the power button for two seconds or longer.

Notice

Check that the system is in standby mode (power indicator red) before turning it off using the MAIN POWER switch on the system rear. If you turn off the system using the MAIN POWER switch when it is not in standby mode, it may cause malfunction or damage to the system.

2 Press the PS button of the Wireless Controller.

A controller number is assigned.

04 Basic operations

Using the SIXAXIS™ Wireless Controller

Preparing for use

To use a Wireless Controller, you must first register or "pair" the controller with the PS3™ system and assign a number to the controller.

Step 1: Pair the system and the controller.

- When using for the first time
- When using with a different PS3™ system



Step 2: Assign a controller number.

Every time the system is turned on

Step 1: Pair the system and the controller

When using the controller for the first time or when using with a different PS3™ system, you must first pair the devices. If you turn on the system and connect the controller using a USB Cable, the pairing will be completed automatically.

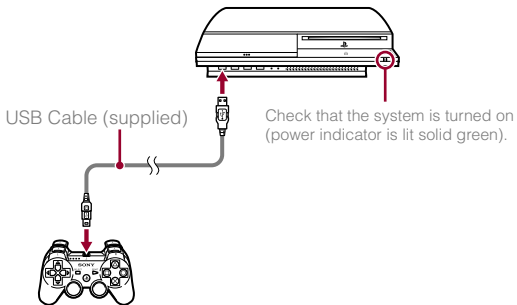

Step 2: Assign a controller number

Each time you turn on the system, a number must be assigned to the controller.

Press the PS button.

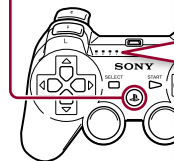

All of the port indicators flash.



When the controller has been assigned a number, the port indicators for the assigned number turn solid red.



You can connect up to 7 controllers at one time. The controller number is shown by the number above the port indicators. For numbers 5-7, add the numbers of the lit indicators.

Example: Controller number 5 has been assigned.

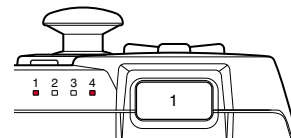

Hints

- Pairing and assigning controller numbers can only be done when the system is turned on (when the power indicator is lit solid green).
- When a paired controller is used with another PS3™ system, the pairing with the original system is cleared. Pair the controller with the system again if the controller has been used with another system.
- If the controller or the system is turned off, the port indicators on the controller will turn off and the assigned number will be cleared.

Using the SIXAXIS™ Wireless Controller

Using the controller wirelessly

If you disconnect the USB Cable, you can use the controller wirelessly. To use it wirelessly, the controller's battery must be charged.

Hint

The USB Cable can be connected or disconnected while the controller and the system are turned on.

Charging the controller

With the system turned on (power indicator is lit green), connect the controller to the system using a USB Cable. The port indicators of the controller flash slowly and charging begins.

When charging has completed, the port indicators stop flashing.

Hints

- The controller can be used while charging.
- Charge in an environment where the temperature range is between 10°C - 30°C. Charging may not be as effective when performed in other environments.

Battery charge level

If you press and hold down the PS button for more than two seconds, you can check the battery charge level on the screen.

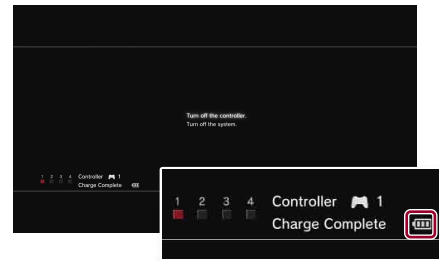

	The battery has plenty of charge.
	The battery has started losing its charge.
	The battery charge level is low.
	The battery has no charge. The port indicators of the controller flash rapidly. Charge the controller.

Hint

Depending on the environment or the conditions of use, the remaining charge level may not display correctly and the battery duration may vary.

05 Basic operations

Playing content

Blu-ray Disc (BD)/DVD/CD

1 Insert the disc.

An icon is displayed in the Home Menu.

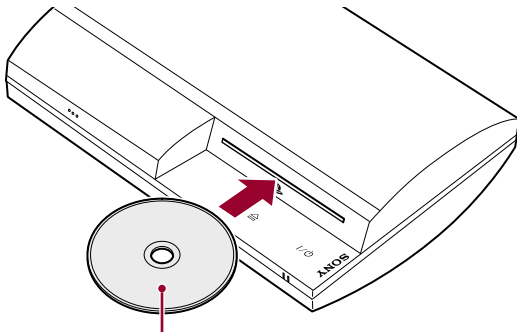

Insert the disc with the label side facing up.

2 Select the icon, and then press the \otimes button.

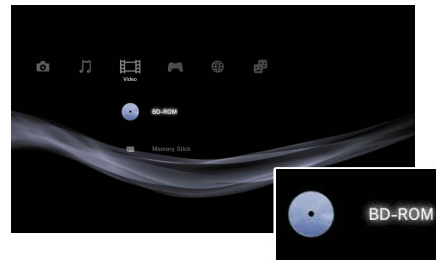

Playback begins.
Depending on the disc, a list of playable content may be displayed.

Ejecting a disc

Stop playback, and then touch the eject button.

Hint

For instructions on how to quit games, see "Playing games" (▶▶ page 19).

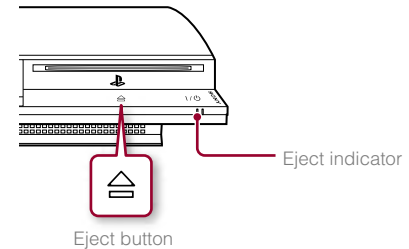

Memory Stick™/SD Memory Card/CompactFlash® (equipped models only)

1 Insert the storage media.

An icon is displayed in the Home Menu.

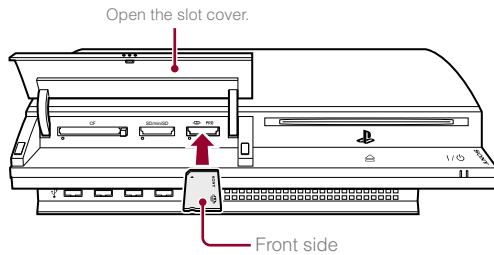

Example: When inserting a Memory Stick™

2 Select the icon, and then press the \otimes button.

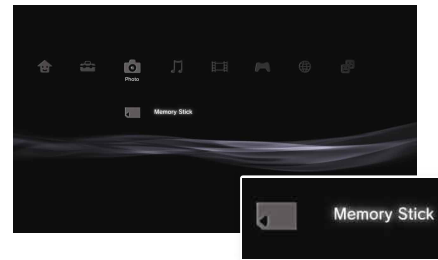

A list of playable content is displayed.

Hint

When using a Memory Stick Duo™/miniSD™ card with the PS3™ system, you can insert the media without using an adaptor.

Ejecting media

Check that the access indicator is not flashing, and then eject.

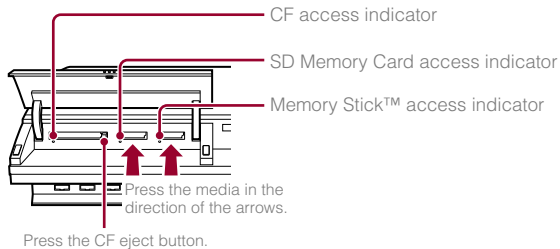

Notice

When the access indicator is flashing, data is being saved, loaded or deleted. When the access indicator is flashing, do not remove the storage media or turn off the system.

USB devices

You can connect external devices, such as devices that are compatible with USB Mass Storage Class using a USB Cable. Devices can be connected while the system is turned on. Refer also to the instructions supplied with the external device to be connected.

1 Connect the USB device.

An icon is displayed in the Home Menu.

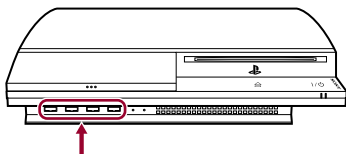

External device such as a digital camera

2 Select the icon, and then press the **X** button.

A list of playable content is displayed.



Notices

- Do not remove USB devices or turn off the system while data is being saved, loaded or deleted. Doing so may cause data loss or corruption.
- When using a USB flash drive with a write-protect switch, do not operate the switch when the device is connected to the PS3™ system. Doing so may cause data loss or corruption.

File formats that can be played or viewed

File formats that can be played or viewed on this system include ATRAC, MP3, AAC, JPEG and MPEG-4. For the latest information, refer to the online user's guide (•▶ page 27).

Hints

- Only files that are playable or viewable on the PS3™ system are displayed in the column for the compatible category (Example: Image data is displayed in the Photo category).
- Depending on the storage media, only a subset of the folders on the media may be displayed. If you select "Display All" from the options menu (•▶ page 3), all folders saved on the media will be displayed.

Notice

You should where possible make periodic back-ups of data stored on the hard disk drive as a precaution against possible loss or corruption. If for any reason software or data loss or corruption occurs, it is not possible to restore or repair the software or data. Note that SCEE will not be liable for any loss or corruption of data, files or software.

06 Game

Playing games

Starting/quitting a game

Starting a game

Insert a disc, select the icon, and then press the  button.

Quitting a game

During gameplay, press and hold down the PS button of the Wireless Controller for at least 2 seconds. Then select "Quit Game" from the screen that is displayed.

When you start or quit PlayStation®2 format software, the assigned controller number is cleared. Follow the steps listed below to assign a controller number.

- After starting a game: Press the PS button when content from the game software is displayed on the screen.
- After quitting a game: Press the PS button when the Home Menu is displayed on the screen.

Certain PlayStation®2 format software titles may not perform properly on this system. Visit faq.eu.playstation.com/bc for the latest information regarding compatible titles.

Hint

To save PlayStation®2/PlayStation® format software data, you must create internal memory cards (▶▶ page 20).

Controller settings

You can adjust controller settings during gameplay. Press the PS button for at least 2 seconds, and then select a settings item from the screen that is displayed.

Switching analog mode

When playing PlayStation®2/PlayStation® format software, you can change the mode of the controller. Switch to the mode supported by the software. With some software, the mode is switched automatically.

Changing controller numbers



You can change the number assigned to a controller. When the controller port for use is specified by the software, change to the supported controller number.*

*You cannot assign controller port 2-D using the PS3™ system.

Hint

You can check the currently assigned controller number by pressing the PS button for at least 2 seconds.

Saved data for PS3™ format software

Saved data for PS3™ format software is saved on the system's hard disk. The data is displayed under  (Game) →  (Saved Data Utility).

Saved data for PlayStation®2/PlayStation® format software

To save data from PlayStation®2/PlayStation® format software, you must create internal memory cards on the hard disk and assign the cards to slots.

Step 1: Create an internal memory card.

Create an internal memory card within the hard disk as a replacement for the Memory Card (8MB) (for PlayStation®2) or Memory Card.



- Memory Card (8MB) (for PlayStation®2)
- Memory Card

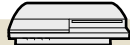

Internal memory card (PS2)
Internal memory card (PS)

Step 2: Assign a slot.

Insert the internal memory card in the internal slot on the hard disk instead of a MEMORY CARD slot on the PlayStation®2 or PlayStation® console.

MEMORY CARD slots

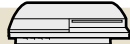

Internal slots



Step 1: Create an internal memory card

- 1 Select (Memory Card Utility (PS/PS2)) under (Game) in the Home Menu, and then press the button.







- 2 Select (New Internal Memory Card), and then press the button.

Follow the on-screen instructions to create the internal memory card.

Internal memory card types

Type		Data type that can be saved
	Internal memory card (PS2)	Saved data from PlayStation®2 format software (Saved data from PlayStation® format software cannot be saved.)
	Internal memory card (PS)	Saved data from PlayStation® format software

Step 2: Assign a slot

- 1 Select  (Memory Card Utility (PS/PS2)) under  (Game) in the Home Menu, and then press the  button.
- 2 Select the internal memory card that you want to use, and then press the  button.



Assign a slot.



Hints

- Depending on the software, slots may be preassigned. For details, refer to the instructions supplied with the software.
- You can assign slots during gameplay. Press the PS button of the Wireless Controller for at least 2 seconds, and then select "Assign Slots" from the screen that is displayed.

Using saved data on a Memory Card (8MB) (for PlayStation®2) or a Memory Card

To use saved data on a Memory Card (8MB) (for PlayStation®2) or a Memory Card, you must copy the data to an internal memory card within the hard disk. You must use a Memory Card Adaptor (sold separately) to copy the data.

- 1 Select  (Memory Card Utility (PS/PS2)) under  (Game) in the Home Menu, and then press the  button.
- 2 Connect the Memory Card Adaptor to the system.
- 3 Insert the memory card that you want to copy in the adaptor.

The icon for  (Memory Card (PS)) or  (Memory Card (PS2)) is displayed.

- 4 Select the icon, and then press the  button.

Follow the on-screen instructions to copy the data.

Hints

- Depending on the type, saved data from a Memory Card (8MB) (for PlayStation®2) or a Memory Card is copied to an internal memory card as shown below.

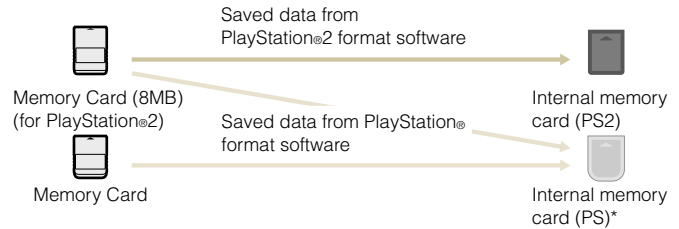

* If the amount of saved data to copy is large, the system will automatically create multiple internal memory cards (PS).

- You cannot copy data saved on the hard disk to a Memory Card (8MB) (for PlayStation®2) or a Memory Card.

07 Network

Adjusting network settings

Using a wired connection

The following instructions explain how to connect to the Internet using an Ethernet Cable.

Example of a wired network configuration

The network configuration and connection method may vary depending on the equipment in use and the network environment.

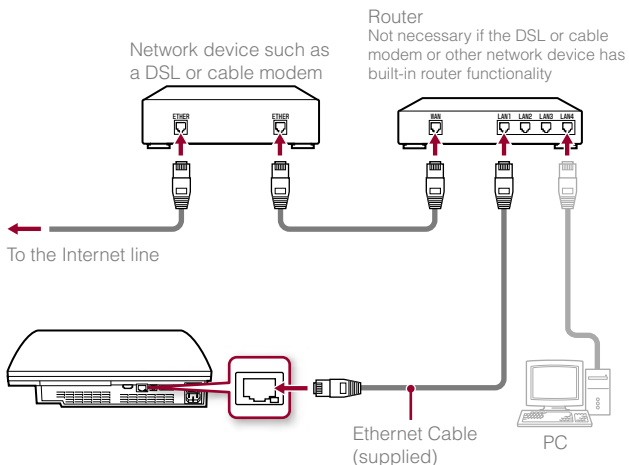

Hint

A router is a device that enables multiple devices to be connected to one Internet line. A router is necessary if a PC and the PS3™ system will be connected to the Internet at the same time.

Preparing the required items

The following items are required for a wired connection to the Internet.

- Subscription to an Internet service provider (ISP)
- A network device, such as a DSL modem or router
- Ethernet Cable (supplied)

Setting up the Internet connection

When making a wired connection to the Internet, usually you do not need to adjust any of the default settings. If you cannot use the default settings to connect, follow the instructions below to adjust the settings.

- 1 Select (Network Settings) under (Settings) in the Home Menu, and then press the button.
- 2 Select "Internet Connection Settings", and then press the button.
When a message stating that the Internet connection will be terminated is displayed, select "Yes", and then press the button.
- 3 Select "Wired Connection", and then press the right button.

Adjusting network settings

4 Select "Easy" or "Custom" and adjust settings as necessary.

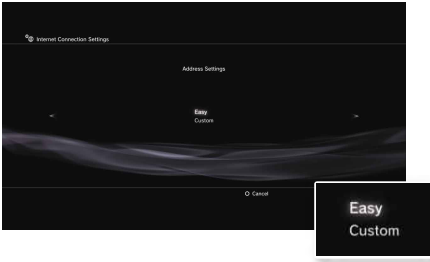

Follow the on-screen instructions to adjust the required settings.

Easy	Basic settings are set automatically.
Custom	You can manually enter detailed settings information. For information on settings, refer to the instructions supplied by the Internet service provider or with the network device.

For detailed information on network settings, refer to the online user's guide (▶▶ page 27).

Using a wireless connection (wireless LAN feature-equipped models only)

The following instructions explain how to connect to the Internet using a wireless connection.

Example of a wireless network configuration

The network configuration and connection method may vary depending on the equipment in use and the network environment.

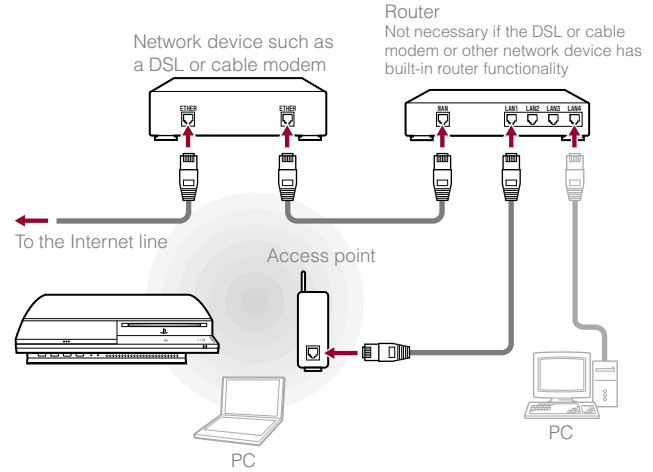

Hint

An access point is a device that enables network connectivity without using a physical cable.

Adjusting network settings



Preparing the required items

The following items are required to set up the system to connect wirelessly to the Internet.

- Subscription to an Internet service provider (ISP)
- A network device, such as a DSL modem or router
- An access point*
- Settings information for the access point (SSID, WEP key, WPA key)

*Not necessary if using a wireless router with built-in wireless functionality



Hints

- When connecting to the Internet wirelessly, signal interference may occur depending on the usage condition of the wireless network devices. If Internet data transfer speed is decreased or the Wireless Controller does not function properly, use an Ethernet Cable to establish a wired connection.
- Depending on the access point in use, you may need the MAC address for your system when connecting to the Internet. You can find the MAC address for the system by going to  (Settings) ➔  (System Settings) ➔ "System Information".

Setting up the Internet connection

When connecting wirelessly to the Internet, you must first adjust network settings.

Network settings may vary depending on the type of access point and the network environment. The following instructions explain the most common network configuration.

1 Select  (Network Settings) under  (Settings) in the Home Menu, and then press the  button.

2 Select "Internet Connection Settings", and then press the  button.

When a message stating that the Internet connection will be terminated is displayed, select "Yes", and then press the  button.

3 Select "Wireless", and then press the right button.

4 Select "Scan", and then press the right button.

The system will search for access points within range and display them as a list.



Hint

In some regions, you may select Automatic Setup by Access Point. When using an access point that supports automatic setup, select "Automatic" and follow the on-screen instructions. The required settings will be completed automatically. For information on access points that support automatic setup, contact the access point manufacturers.

Adjusting network settings

- 5 Select the access point that you want to use, and then press the \otimes button.**

An SSID is a code or a name that is assigned to the access point. If you do not know which SSID to use or if the SSID is not displayed, contact the person who set up or maintains the access point.



- 7 Select the security settings as necessary, and then press the right button.**

Security settings vary depending on the access point in use. To determine which settings to use, contact the person who set up or maintains the access point.

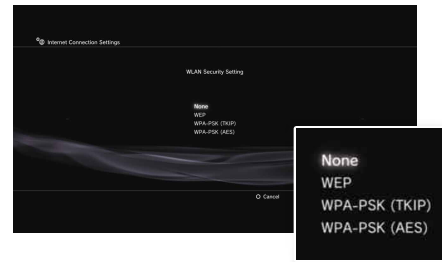

- 6 Confirm the SSID for the access point, and then press the right button.**

- 8 Enter the encryption key, and then press the right button.**

The encryption key field will display an asterisk (*) for each character you enter. If you do not know the key, contact the person who set up or maintains the access point.

9 Select "Easy" or "Custom" and adjust settings as necessary.

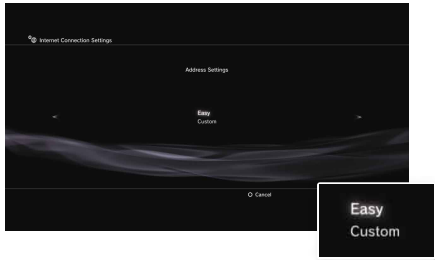

Follow the on-screen instructions to adjust the required settings.

Easy	Basic settings are set automatically.
Custom	You can manually enter detailed settings information. For information on settings, refer to the instructions supplied by the Internet service provider or with the network device.



For detailed information on network settings, refer to the online user's guide (▶▶ page 27).

08 Network

Connecting to the Internet

If network settings are already completed, the PS3™ system will automatically connect to the Internet when the system is turned on. The connection will remain active as long as the system is on.

Using the Internet browser

- 1 Select  (Internet Browser) under  (Network) in the Home Menu, and then press the  button.

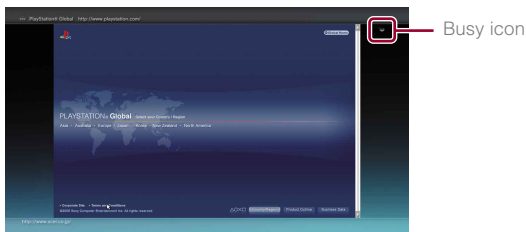

The Internet browser opens. A busy icon is displayed while the page is loading.



Basic operations of the Internet browser

Directional buttons	Move the pointer to a link
Right stick	Scroll in the desired direction
L1 button	Go back to the previous page
START button	Enter an address
 button	Switch between displaying and not displaying the menu

Viewing the user's guide





You can use the Internet browser to view the online user's guide for the PS3™ system. Select  (Online Instruction Manuals) under  (Network) in the Home Menu, and then press the  button.

PLAYSTATION®3 system user's guide

<http://manuals.playstation.net/document/>

The guide can also be viewed using your PC's Web browser.

Creating a PLAYSTATION®Network account

By creating a PLAYSTATION®Network account, you can enjoy chatting under  (Friends) or use the PS3™ system's online network service and other features. Go to , select  (Sign Up for PLAYSTATION®Network), and then press the  button. The screen for creating an account will be displayed.



Hints

- An Internet connection is required to create an account.
- PLAYSTATION®Network service content may vary depending on the region.

09 Updates

PS3™ system updates

By updating the PS3™ system software, you can add features and/or security patches. Frequently update your system to use the latest version of the system software.

For the latest information on updates, visit <http://eu.playstation.com/ps3>.



Use the update data to overwrite the existing system software.

The system software is updated.

Notices

- During an update, do not turn off the system or remove media. If an update is cancelled before completion, the system software may become damaged, and the system may require servicing or exchange.
- During an update, the power button on the system front is inactive.
- Depending on the content, you may not be able to play without first updating the system software.
- After you have updated the system software, you cannot go back to an earlier version.

Update methods

You can perform an update in any of the ways described below.

Network update

You can update by downloading the update data from the Internet. The latest update is automatically downloaded.

Select (Settings) ➔ (System Update) ➔ "Update via Internet".

Update using storage media

You can update using the update data saved on a Memory Stick™ or other media.

Select (Settings) ➔ (System Update) ➔ "Update via Storage Media".

Hint

Update data can also be contained in some game discs.

Checking the system software version

You can check system version information by selecting (Settings) ➔ (System Settings) ➔ "System Information". The current version is displayed in the System Software field.

Using the on-screen keyboard

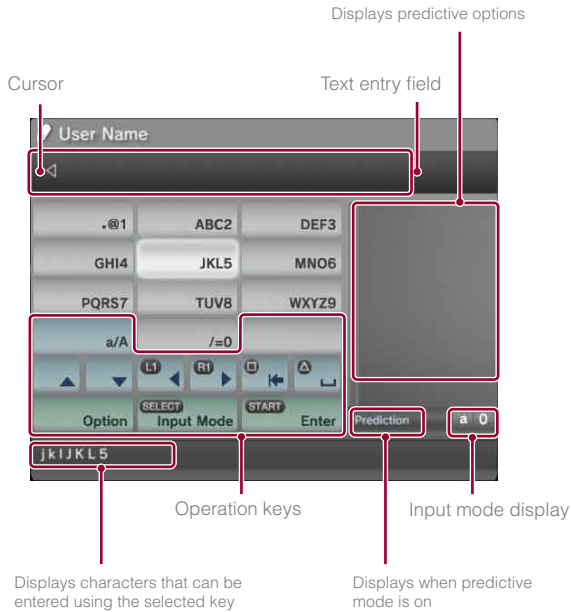

List of keys

Keys that are displayed vary depending on the input mode and other conditions.

Keys	Explanation
	Inserts a line break
	Moves the cursor
	Deletes the character to the left of the cursor
	Inserts a space
	Displays the options menu
	Switches the input mode
	Confirms characters that have been typed but not entered, and exits the keyboard

Using the on-screen keyboard

Entering characters





Using predictive mode, you can enter the first few letters of the word, which will bring up a list of commonly used words that start with these letters. You can then use the directional buttons to select the word that you want. After you have finished entering text, select the "Enter" key to exit the keyboard.

Hint



You can also use the single tap text entry method. Use the "Options" key to switch the text entry method. When using single tap, words that can be created using combinations made from one letter (or number) on each selected key are displayed as candidate terms. For example, if you select the "DEF3" key, words beginning with d, e, f or 3 are listed in the candidate terms window on the right side of the on-screen keyboard. If there are no candidate terms, the symbol ">" is displayed.

Input mode types

Input mode types depend on the system language selected.

Input mode display	Input mode	Examples of characters you can enter
	English	a b c d e 1 2 3 4 5
	ABCÀ	é í ó ç ñ 1 2 3 4 5
	123	1 2 3 4 5
	URL	.com/ .net/ html gif

Hint

The languages you can use for text entry are the supported system languages. You can set the system language by going to  (Settings)  (System Settings)  "System Language".

Example: If "System Language" is set to "Français", you can enter text in French.

Using a USB keyboard

You can enter characters using a USB keyboard (sold separately). While the text entry screen is displayed, if any key on the connected USB keyboard is pressed, the text entry screen will enable you to use the USB keyboard.

Hint

You cannot use the predictive mode when using a USB keyboard.





SONY



COMPUTER
ENTERTAINMENT

www.playstation.com

"PS", "PlayStation", "PLAYSTATION", and "△ ○ × □" are registered trademarks of Sony Computer Entertainment Inc. Also, "PS3" and "SIXAXIS" are trademarks of the same company. "XMB" and "cross media bar" are trademarks of Sony Corporation and Sony Computer Entertainment Inc.

"SONY" and "Ⓜ" are registered trademarks of Sony Corporation. Also, "Memory Stick", "Memory Stick Duo", "MEMORY STICK" and "ATRAC" are registered trademarks or trademarks of the same company.

"Blu-ray Disc" is a trademark.

HDMI, the HDMI logo and High-Definition Multimedia Interface are trademarks or registered trademarks of HDMI Licensing, LLC.

Sony Computer Entertainment Inc. is an authorised licensee of the CompactFlash® registered trademark.

All other trademarks are the properties of their respective owners.

Images shown in this document may vary from the images on your PS3™ system, depending on the system software version in use.